

A dining table for 6, convertible to a double bed

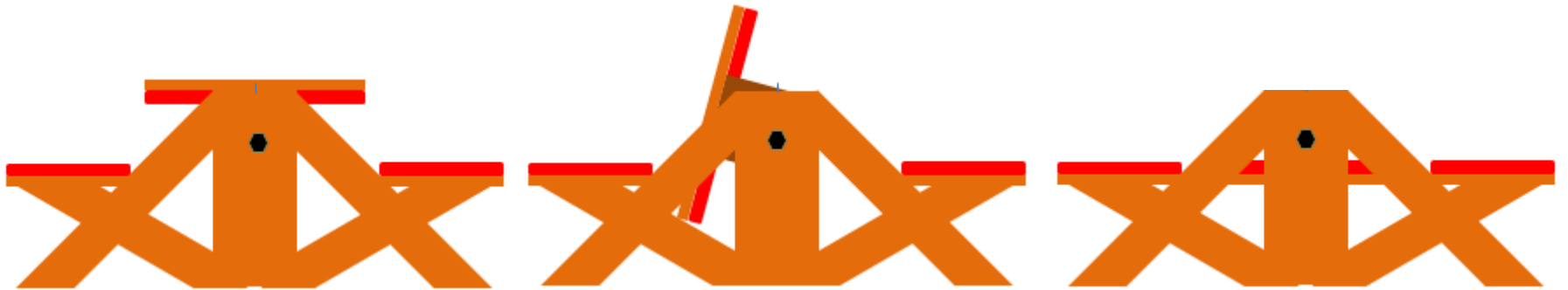

tor@helgesen360.com

DINING TABLE FOR 6

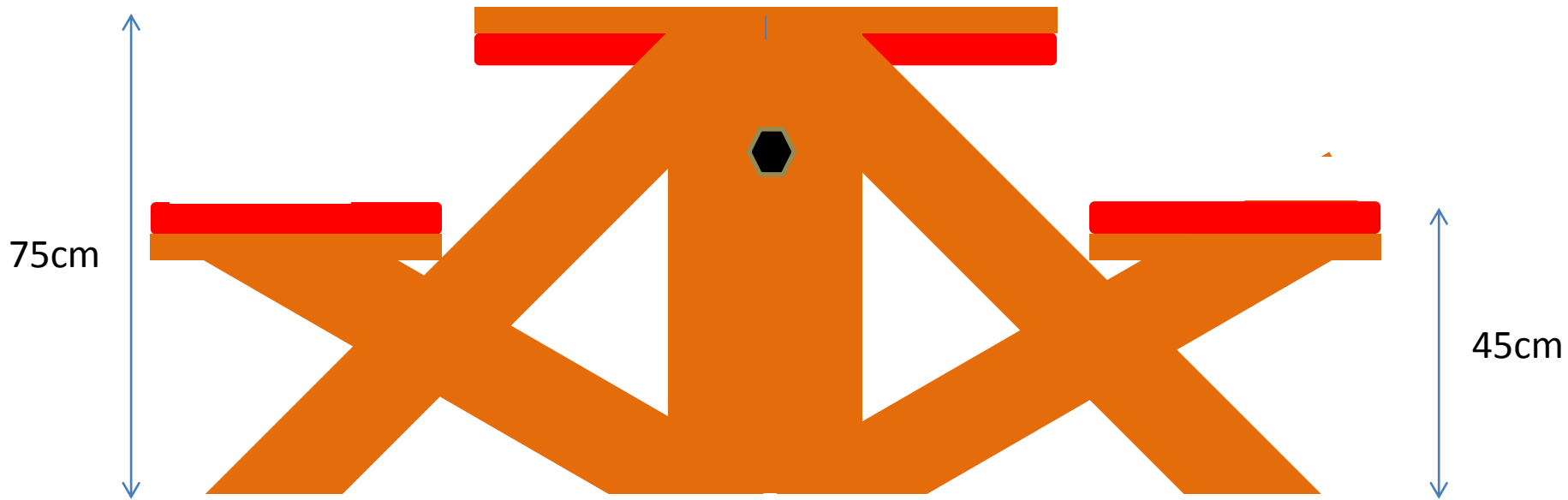
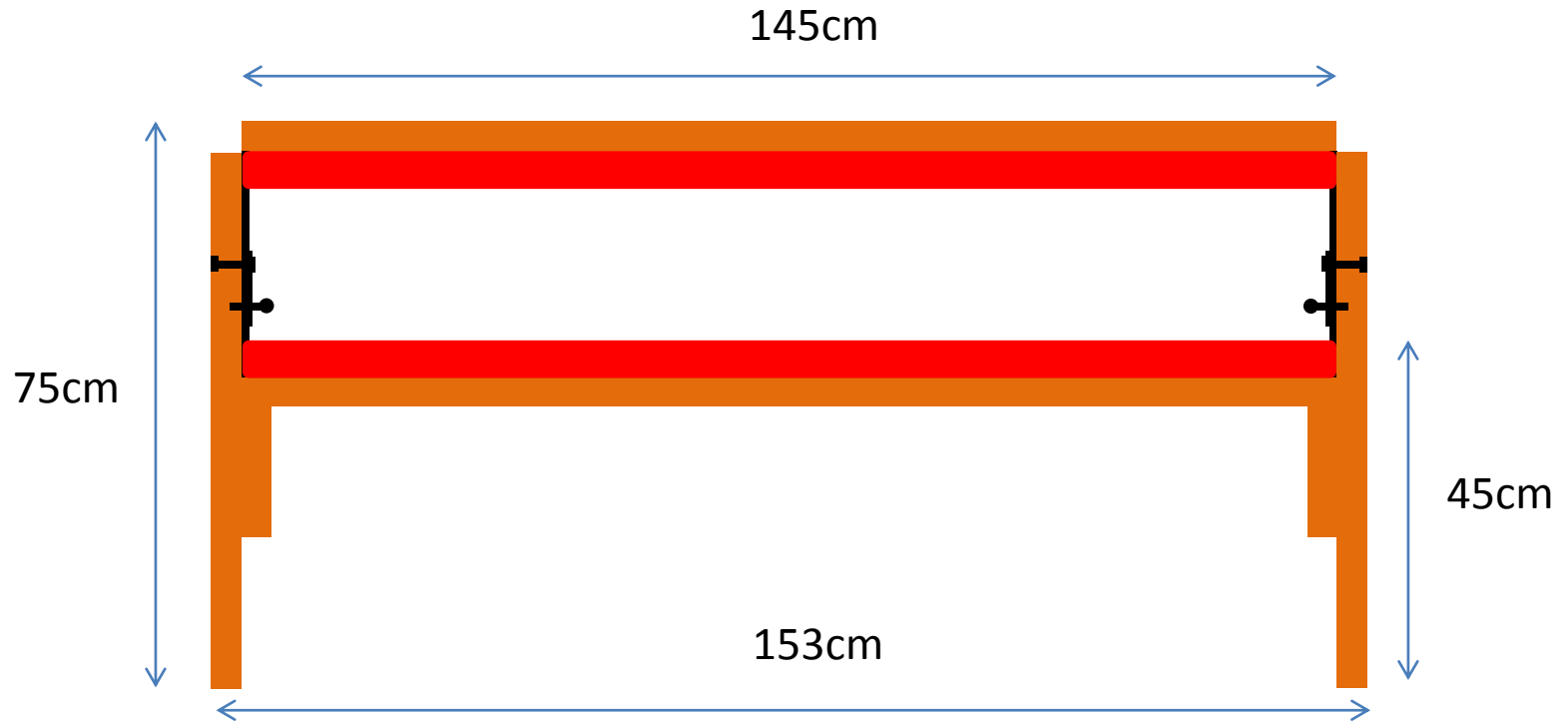

Table size 145 x 90 cm

**A mahogany & fabric covered foam construction
(bed and seat top attached to the wood with velcro)**



TOP VIEW

Foam covered with durable fabric make the seats

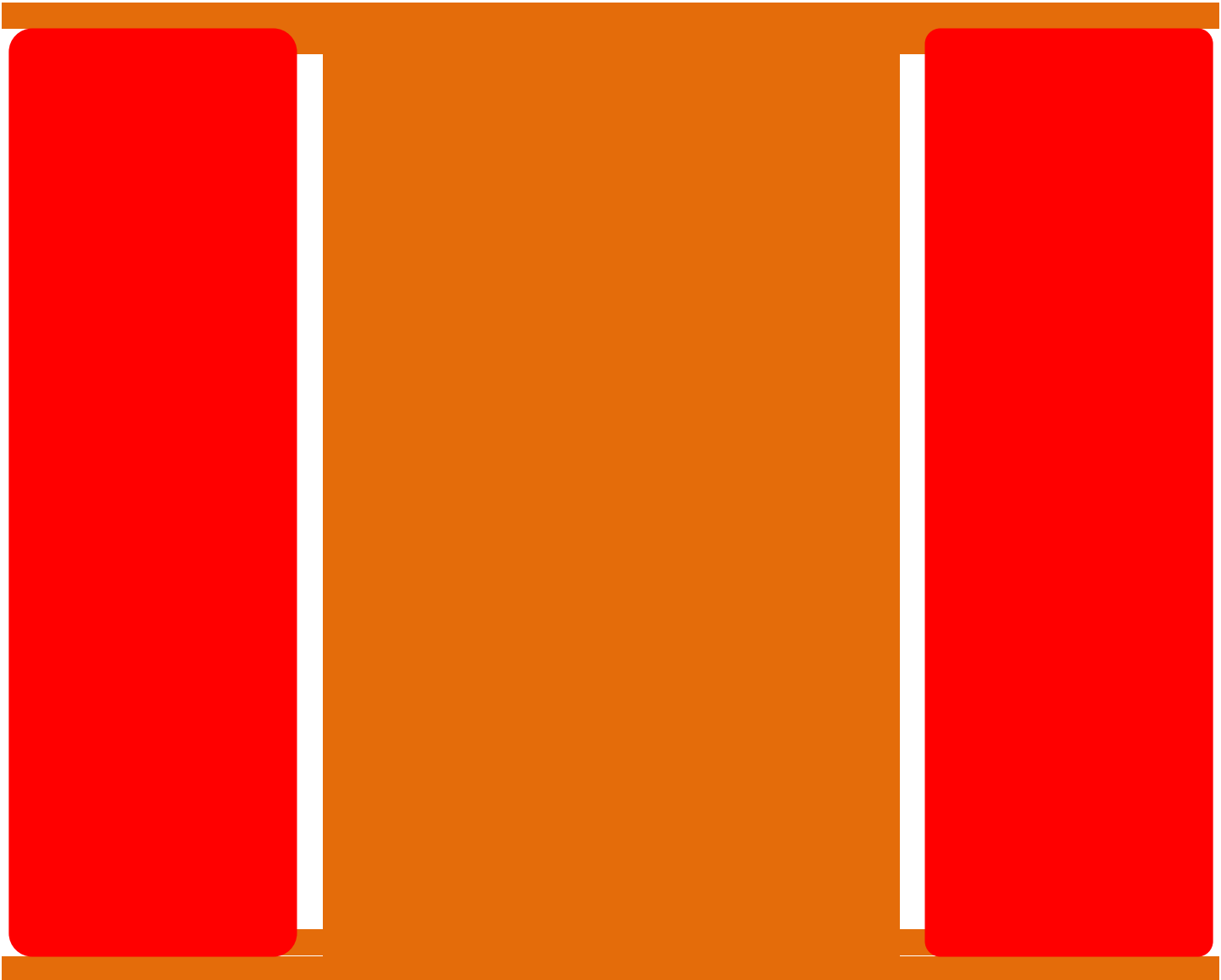
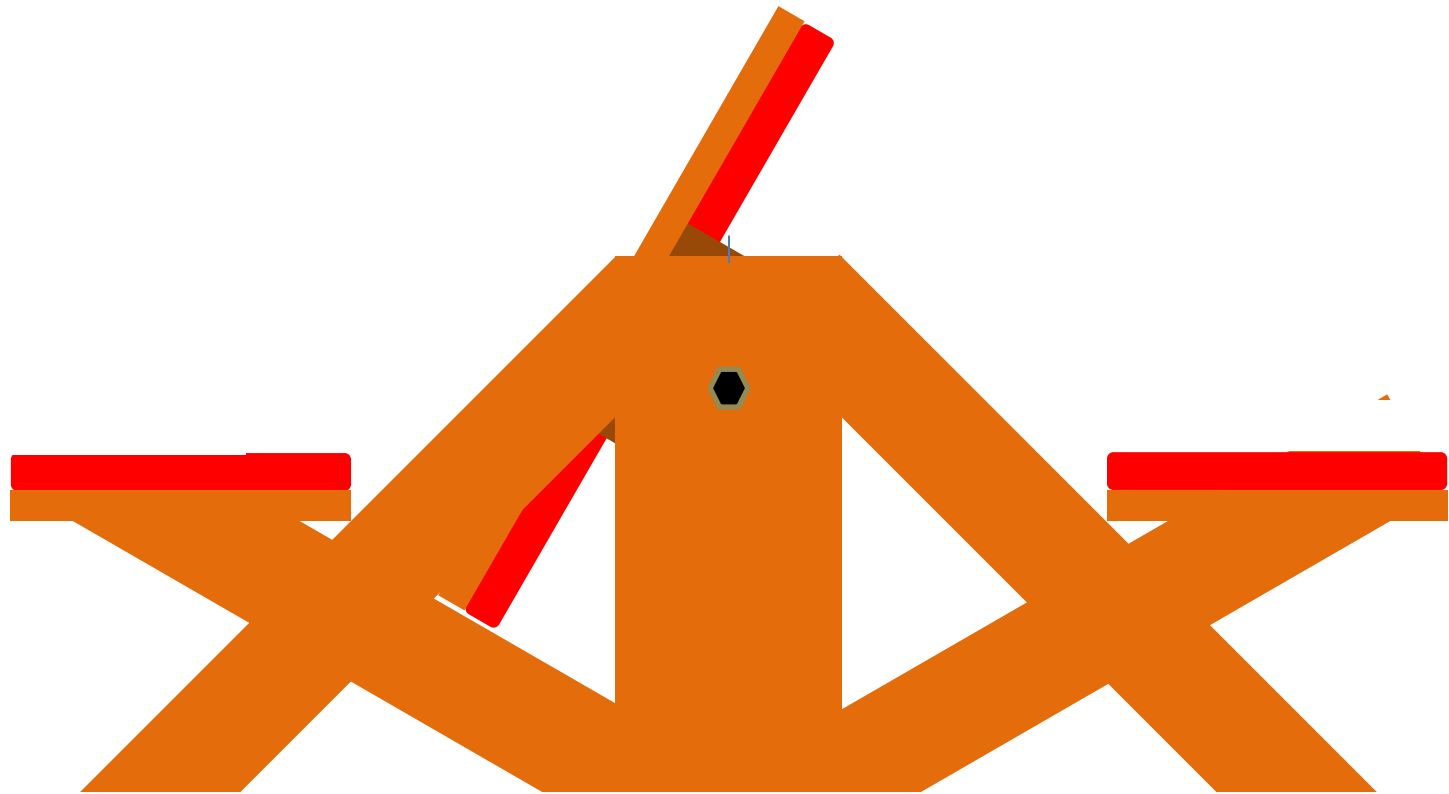
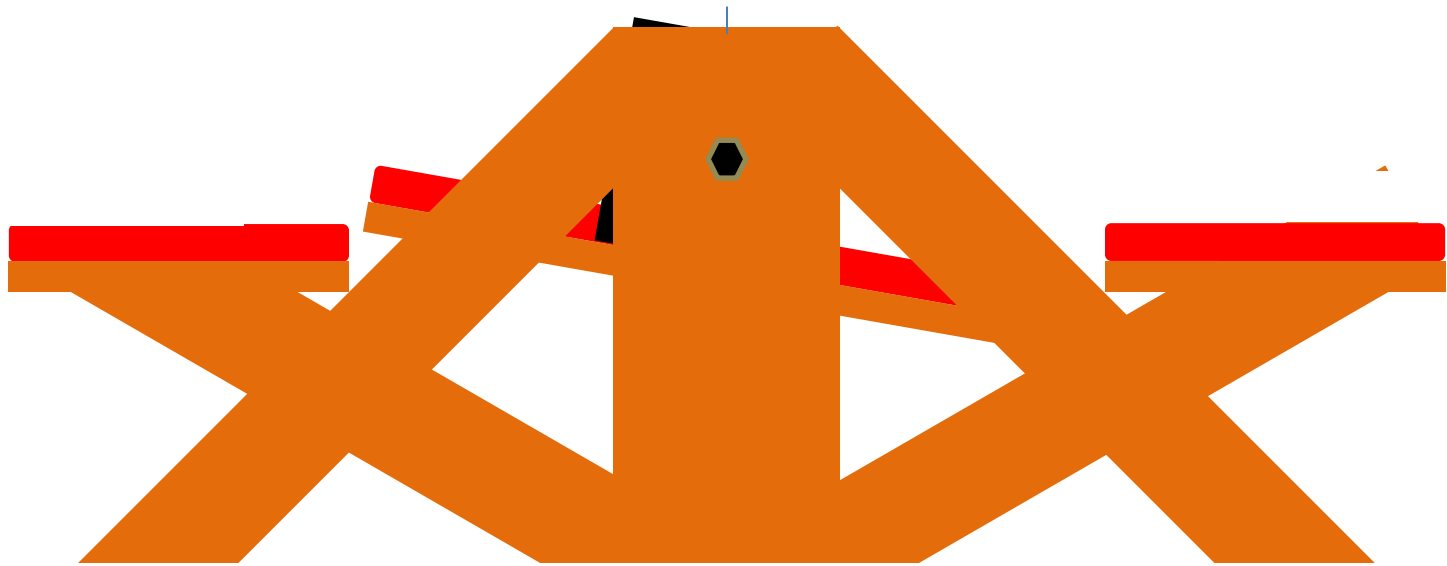

Table size 145 x 90 cm

convertible



to.....



A DOUBLE BED

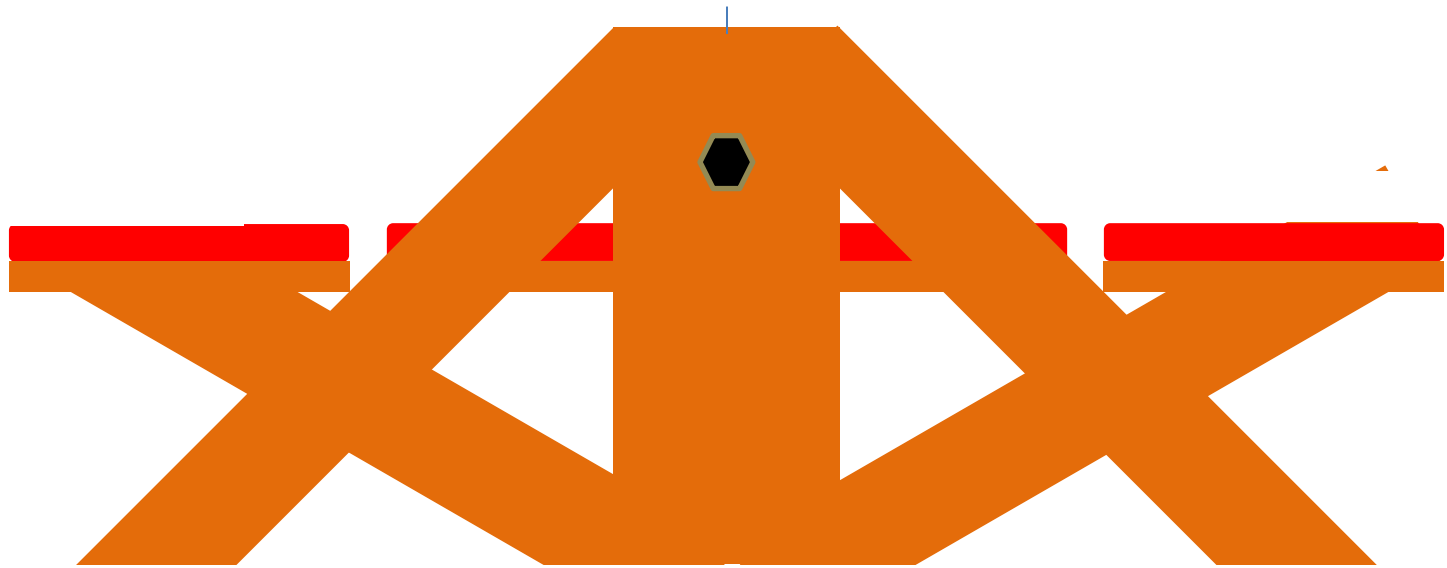

TOP VIEW

Foam covered with durable fabric make the bed top

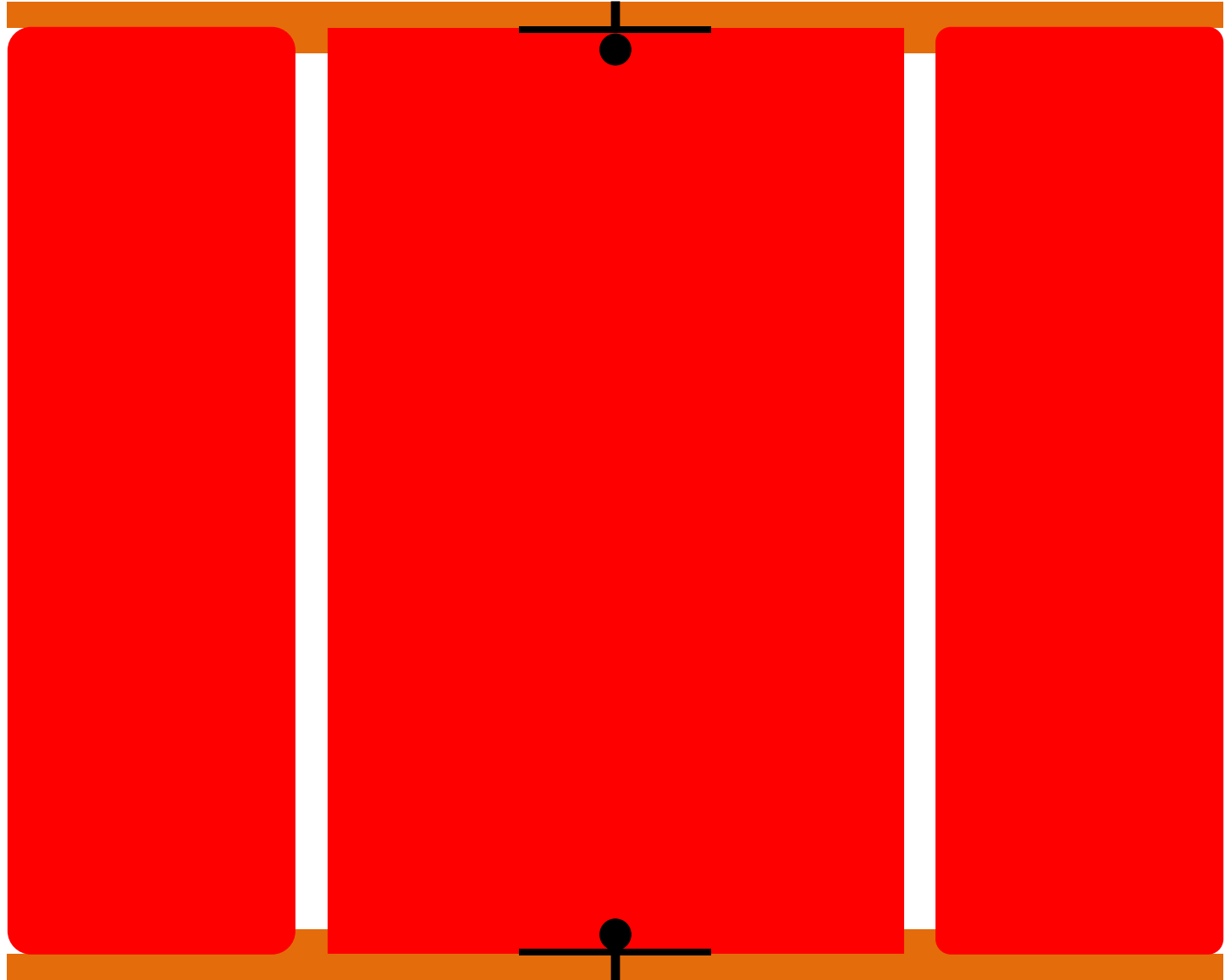

Bed size 145 x 190 cm

PAPER MODEL

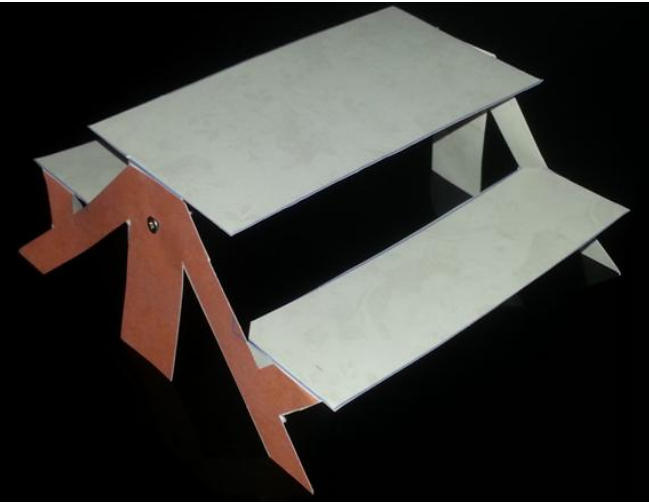

Table

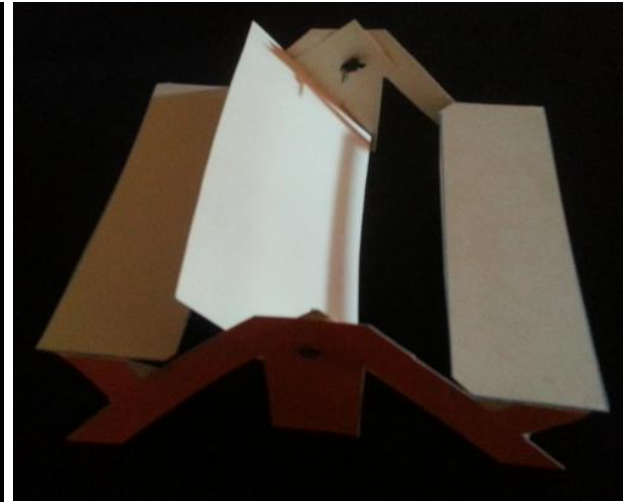

in transit

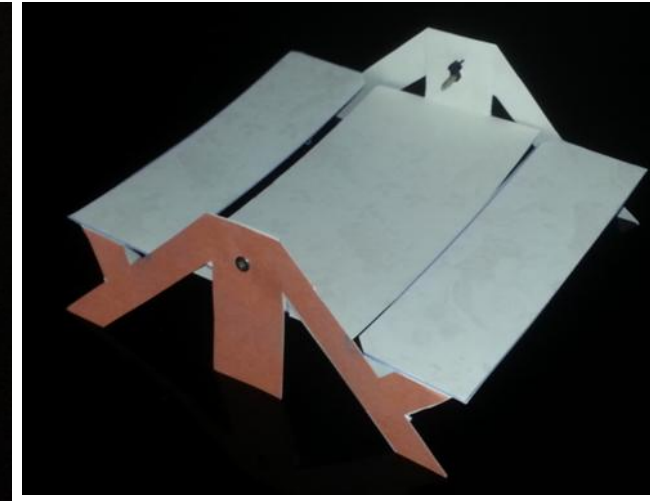

Bed

This is some pictures of a paper modell while propotype is pending.

SIDE CONSTRUCTION 1 of 3

190 x 15 x 4 cm
71cm x 30 x 4 cm

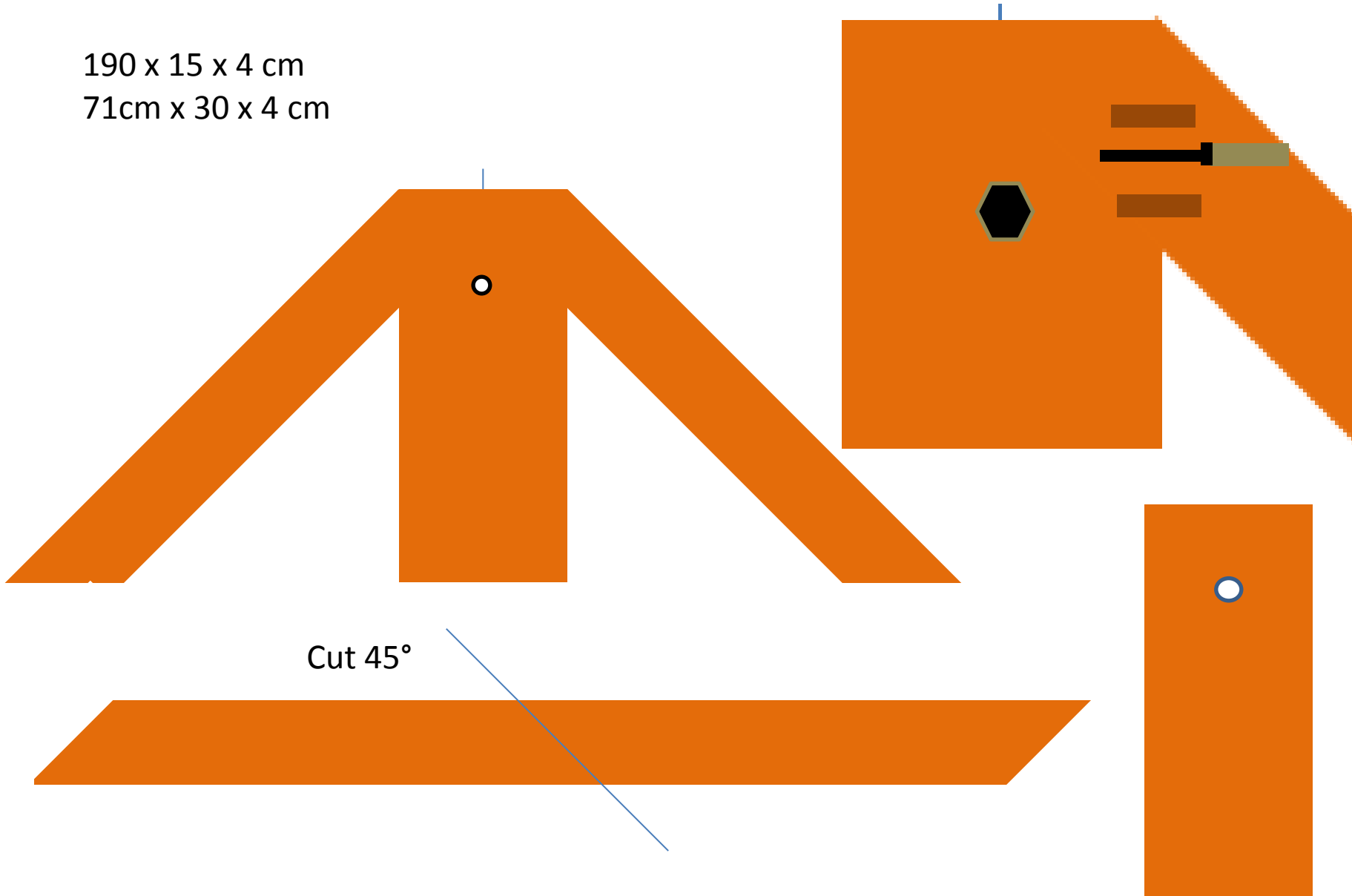

SIDE CONSTRUCTION 2 of 3

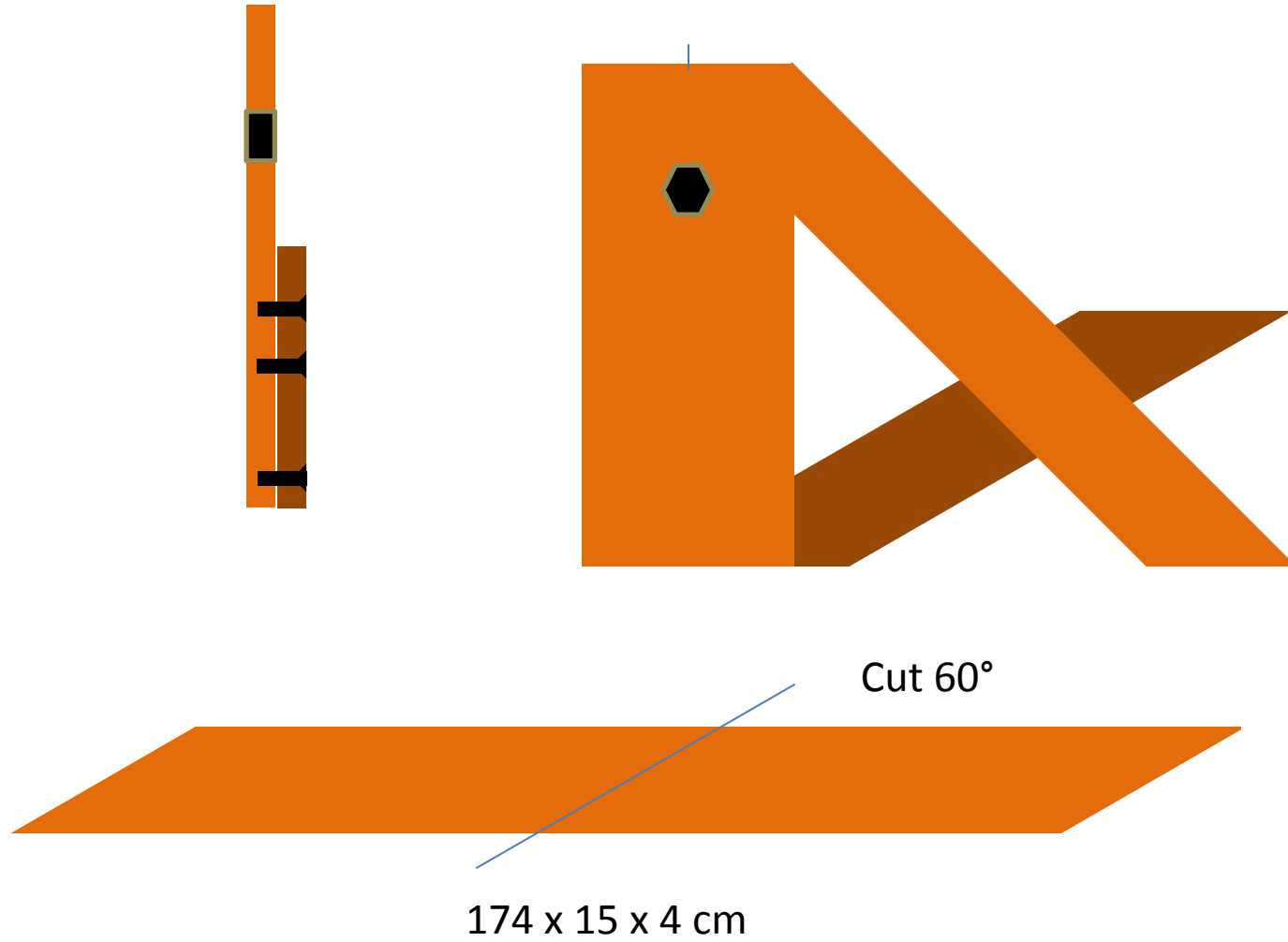

SIDE CONSTRUCTION 3 of 3

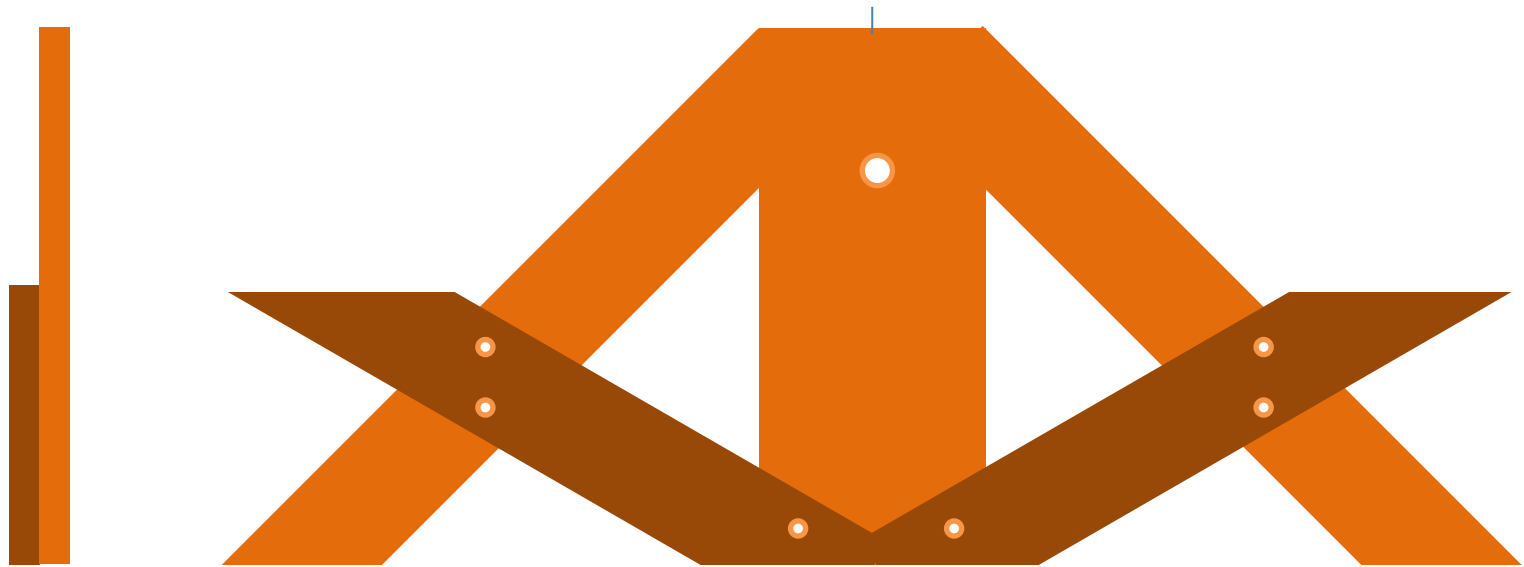

FLATPACK

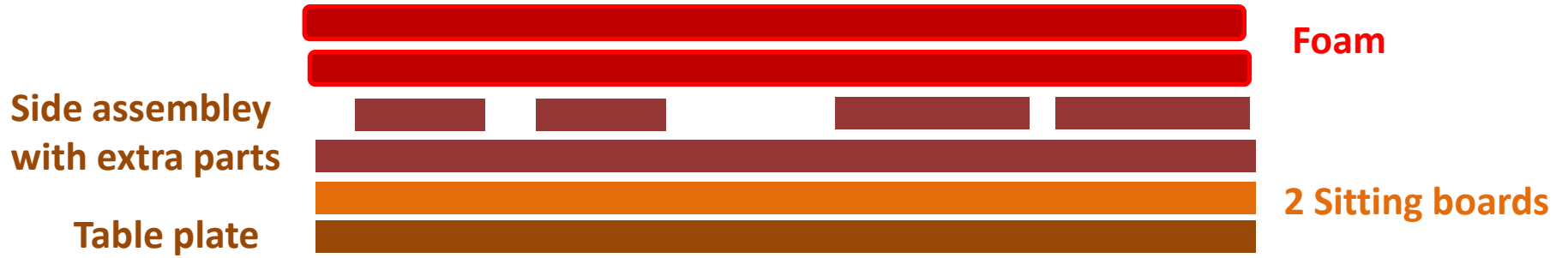

146 x 91 x 42 cm



FLATPACK PARTS 1 of 2

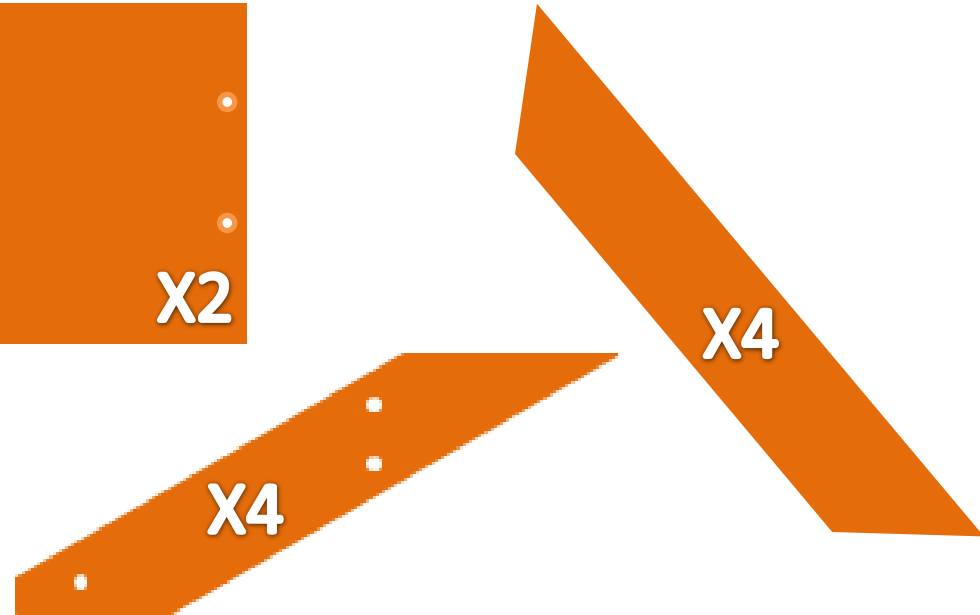

FLATPACK PARTS 2 of 2

Foam covered with durable fabric for sitting board
(cover zipped for cleaning)

X2

Foam covered with durable fabric for bed
(cover zipped for cleaning)

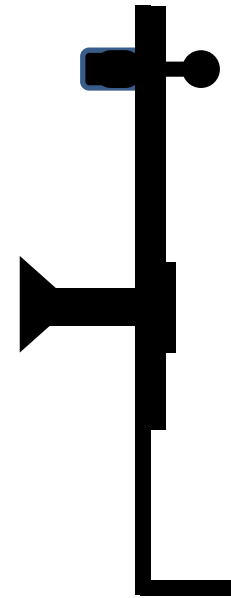

Lock
mechanics



Unbraco key



Velcro



Wood plugs



Screws

CONSTRUCTION PRINCIPALS METAL LOCK MECHANISMS

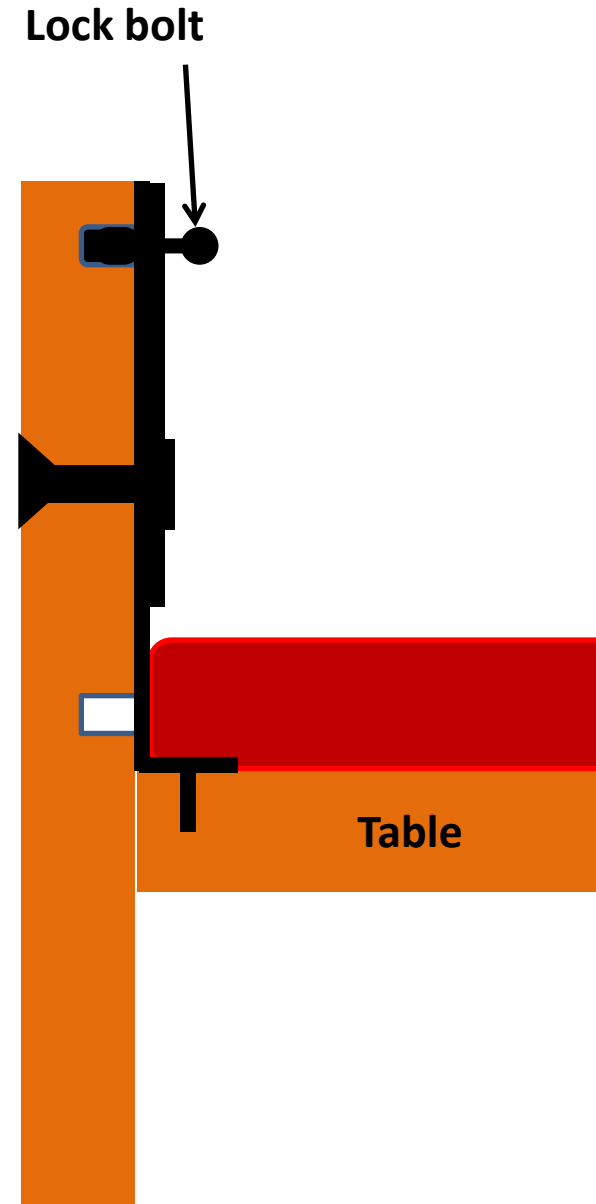
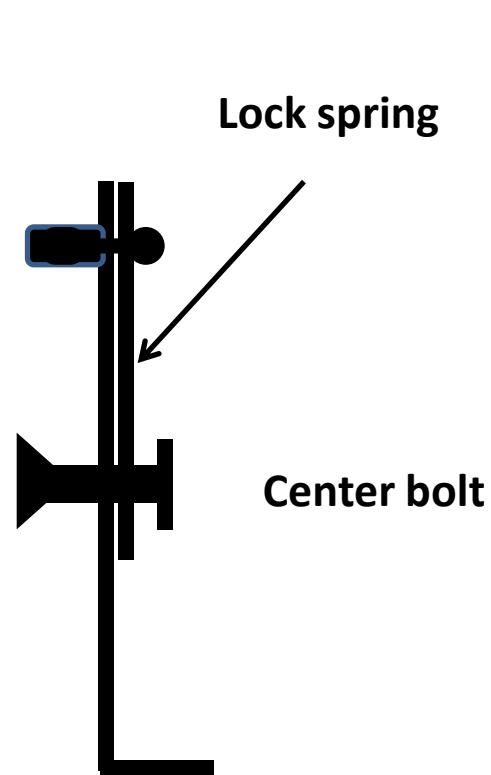
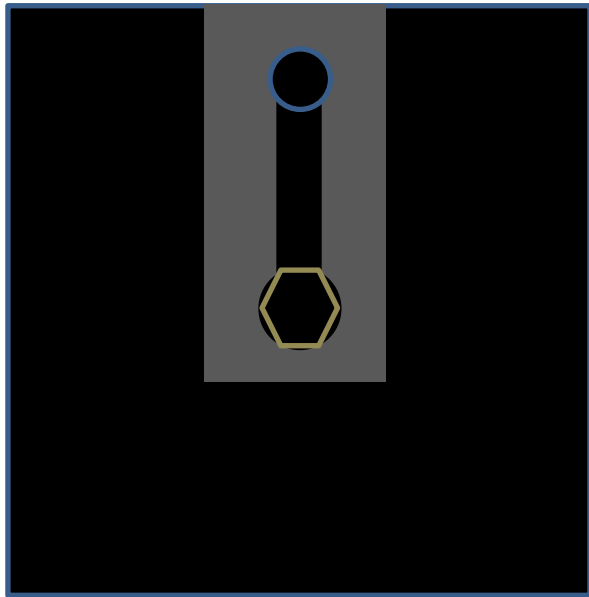

CONSTRUCTION PRINCIPALS LOCK MECHANICS

Locked as bed

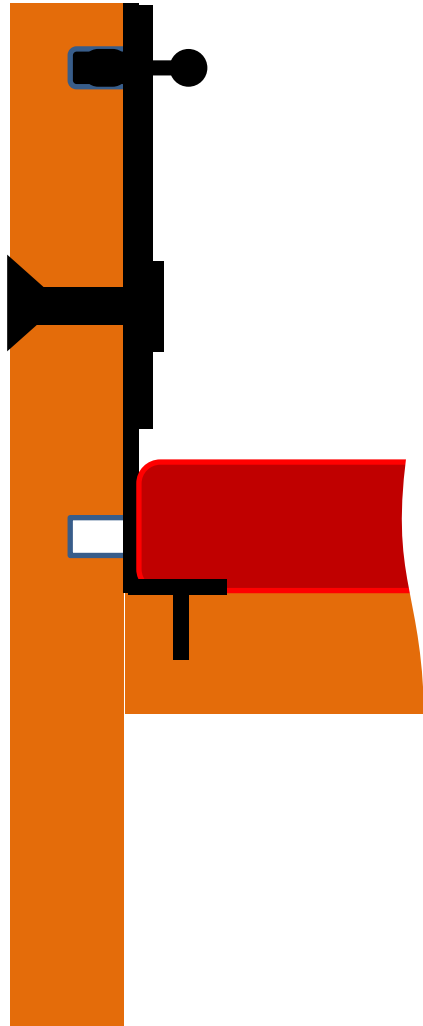

unlocked

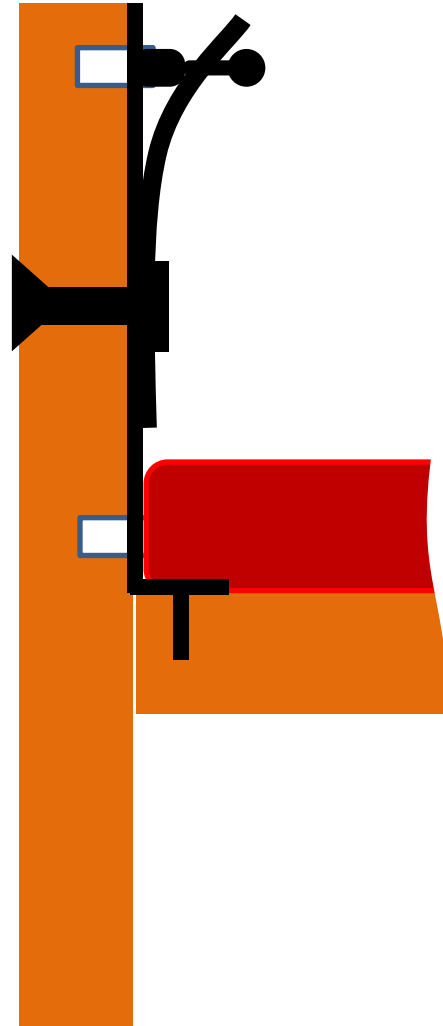

locked as table

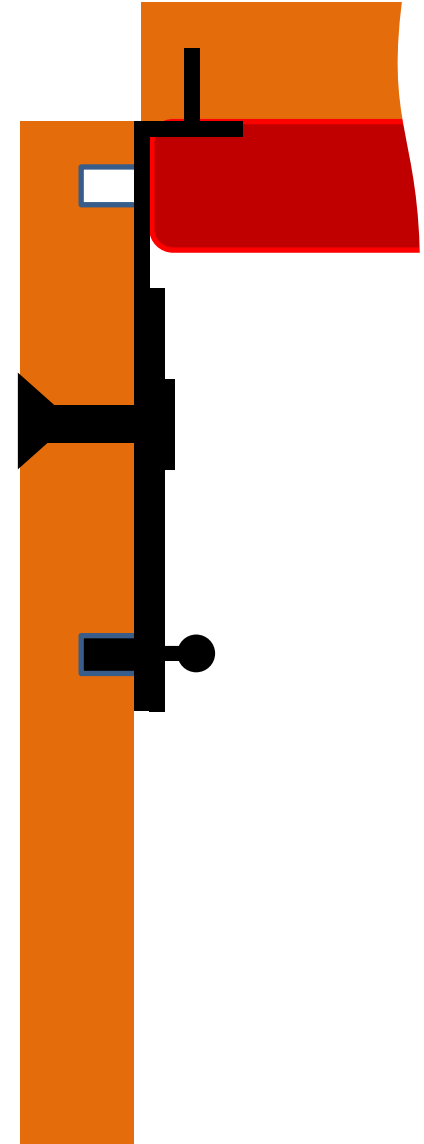

Tor Helgesen © 2013

tor@helgesen360.com

+63 92 02 94 16 08